



Rotary Evaporator

Rotary Evaporator



Vacuum gauge (Option)

Rotary Evaporator

Rotary evaporators (also known as “Rotovaps”) are mainly used for distillations/separation applications often used for medicinal chemistry, pharmaceutical, chromatography, and petrochemical fields. In summary the system works by increasing the rate of evaporation of the solvent by

- (1) reducing the pressure to lower the solvent boiling point
- (2) rotating the sample to increase the effective surface area
- (3) heating the solution
- (4) then the evaporated solvent then condenses in a cooled glass condenser.

BEING Rotary Evaporator features

- Simple design for one handed operation manually or automatically.
- A unique PTFE sealing system provides exceptional thermostability, minimizes corrosion, and helps to ensure day in day out headache free operation.
- Our Bath offers a dual heating mode for water and oil with overheat protection.
- PID controller offers easy input of parameters and large LCD display for easy viewing.
- Vacuum regulator available.



High efficiency can be cycle used for two Rotary Evaporators

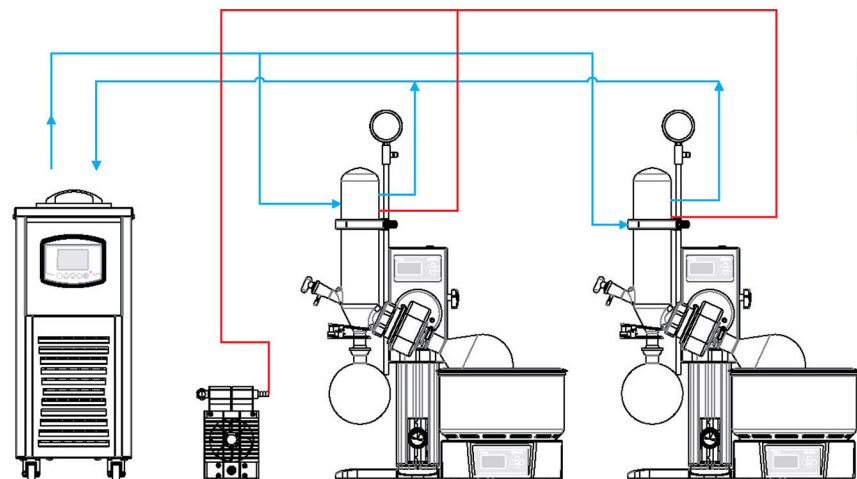

Standard :DIN-12880

Independent temperature safety equipment, 2 class (DIN12880) .

Cooling ————
Reduce pressure ————

Working condition

- Ambient temp 20°C , AC 220V-240V, 60Hz
- 1L Rotary bottle, Water 500ml
- Water Bath temp: Set at 40°C
- Coolant (alcohol/water): set the temperature at 10°C
- Rotation speed: 120rpm

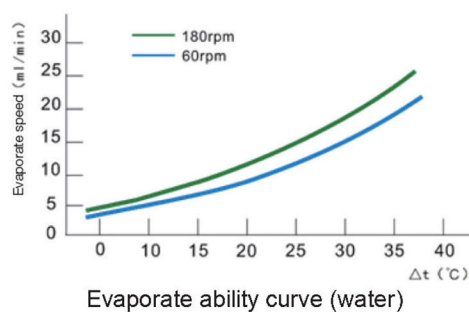
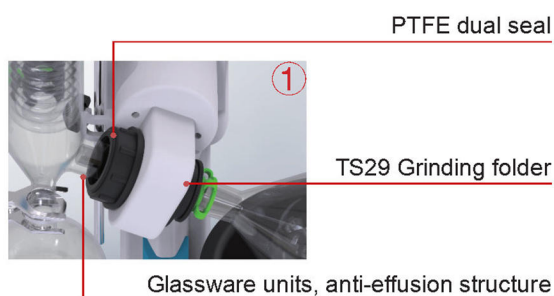

Technical parameters

Model		GentianaRV-21M	GentianaRV-21A
Performance	Rotation speed	20-180rpm	
	Water bath temperature range	Water: RT+5~99°C , Oil: RT+5~180°C (Option)	
	Evaporating speed	22ml/min	
	Ultimate vacuum	8mbar	
Features	Speed setting	LCD display with knob	
	Lifting mode	Manual	automatic
	Motor function	N/A	DC brushless motor
Structure and composition	Main motor DC brushless	DC brushless motor	
	Condenser	Snake Condensate Condensate Area 0.15m ² , 1L Rotary Bottle, 1L Collecting Bottle, TS29 / 38 Bottle Clamp, Ball Face S35 / 20	
	Vacuum seal	PTFE and Teflon Coating	
Heating bath	Interior wather bath size	φ 230mmx130mm	
	Water bath material	Stainless steel Corrosion resistant coating	
	Heating power	1000W	
Temperature range		5~35°C	
Electrical input		AC 220V-240V, 60Hz	

Rotary Evaporator



GentianaRV-5A



GentianaRV-10A



GentianaRV-20A



GentianaRV-50A

Features

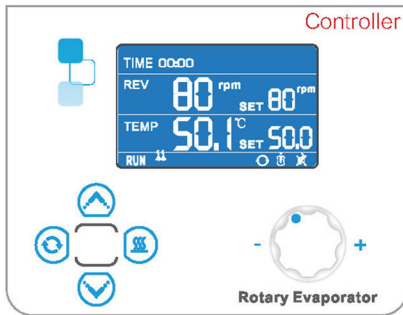

- Scheduled operation
- Rpm set/ display
- Temperature set/ display
- Running status

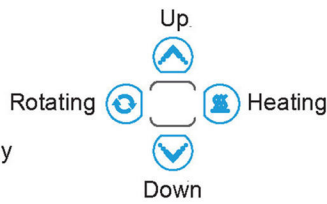

One-button operation

- ▲ Long press to lift or lower the bath
- Press to heat the bath
- ⊞ Press to start/ stop rotating

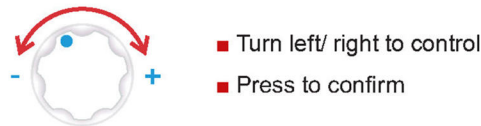

■ Evaporating ability

Ambient temperature: 20°C
▲ t means: the difference between steam and water bath

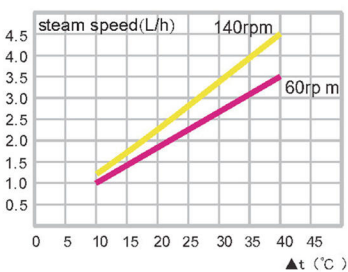

■ Vacuum degree

Vacuum pump required
Flow rate: 50L/min

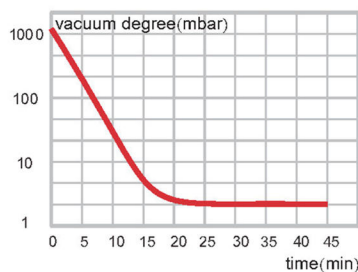

■ Water bath heating

Ambient temp.: 20°C
Medium: Water
Power: AC 220V-240V, 60Hz
Set: 80°C

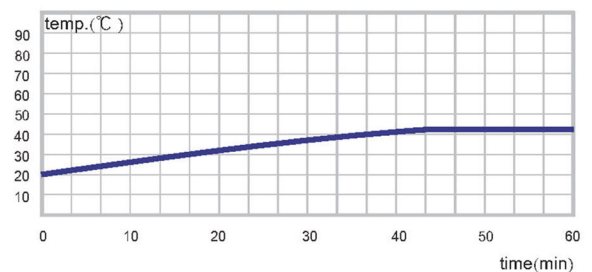

Technical parameters

Model		GentianaRV-5A	GentianaRV-10A	GentianaRV-20A	GentianaRV-50A
Size		5L	10L	20L	50L
Performance	Rotation speed (rpm)	20-140	20-130	20-130	20-110
	Evaporate rate (Max. L/h)	2	3.5	4	9
	Ultimate degree(mbar)	8mbar			
	Temperature rate(°C)	Water: RT+5~99°C , Oil: RT+5~180°C (Option)			
	Temperature stability (°C)	±1			
Function	Controller	PID controller			
	Safety	1.Over current protection 2. Over temp. protection 3. Power interruption alarm 4. Anti-dry protection			
	Display	LCD screen			
	Lift mode	Auto lift			
	Power (W)	2300	3300	4300	5300
	Condensation area(M ²)	0.28	0.49	1.29	1.75
	Capability of rotatory bottle	5L	10L	20L	50L
	Capability of collecting bottle	3L	5L	10L	20L
	Sealing gasket	PTFE and Teflon Coating			
	Lifting distance(mm)	150	170	170	260
Bracket		No	Aluminum alloy bracket		
Water Bath	Dimension(mm)	Diameter 280×175	Diameter 365×225	Diameter 445×250	Diameter 552×320
	Material	SUS304 Water Bath + PTFE Teflon coating			
Interface size	Condenser barb size(mm)	14	18		
Exterior dimension (including glasswares) W×D×H(mm)		860×410×1120	1100×540×2060	1200×570×2060	1300×610×2150
Power		AC 220V-240V, 60Hz			
Ambient temperature		10-35°C			